

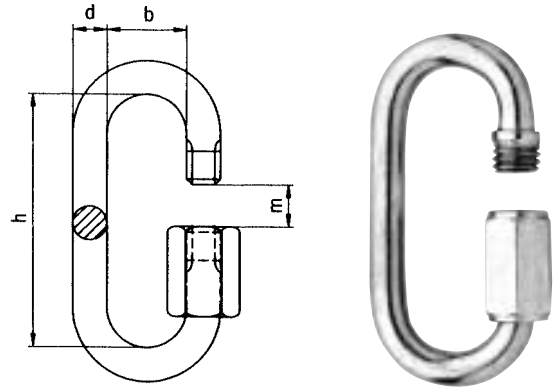

Quick-links
Quick-links
Quick-links
Maillons rapides

Verzinkt/verzinkt/galvanized/zingué



 Art.no.	d	b	m	h	Gewicht Gewicht Weight Poids kg/100	St./Pcs.
	mm	mm	mm	mm		
200-03E	3,5	10	5	29	1,2	100
200-04E	4	11,5	5,5	31,5	2,1	100
200-05E	5	13	6,5	38	2,2	100
200-06E	6	14	7,5	45	3,6	100
200-07E	7	16	8	52	5,0	50
200-08E	8	18	10	60	7,8	50
200-09E	9	19	11	64	10,0	50
200-10E	10	20	12	69	13,8	25
200-12E	12	25	15	83	20,0	25

Noodschakels
Notglieder
Lap-links
Fausses mailles

E = Verzinkt/verzinkt/galvanized/zingué
 B = Blank/blank/polished/poli

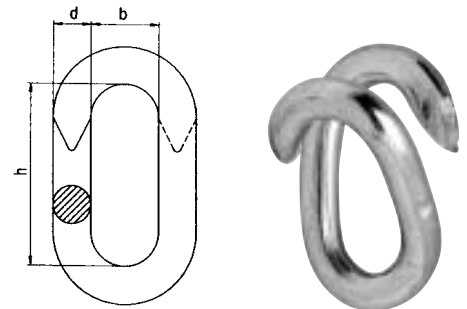

 Art.no.	d	b	h	Gewicht Gewicht Weight Poids kg/100	St./Pcs.
	mm	mm	mm		
250-03	3	6,5	17,0	0,37	100
250-04	4	8,0	19,0	0,80	100
250-05	5	9,5	25,0	1,20	100
250-06	6	10,5	27,0	2,10	100
250-07	7	13,0	30,0	3,90	50
250-08	8	15,0	36,5	5,60	50
250-09	9	16,5	37,5	7,60	50
250-10	10	17,0	37,5	9,50	25

09.2005

Klapachten
Stellachten mit Klappe
Adjustine hooks with tongue
Huits de réglage avec ardillon
 Verzinkt/verzinkt/galvanized/zingué

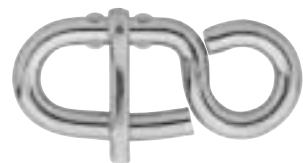

	Materiaal Draht Wire Fil Ø mm	Lengte Länge Length Longueur mm	Gewicht Gewicht Weight Poids kg/100	St./Pcs.
Art.no.				
365-060E	6	60	3,7	100
365-070E	6	70	4,5	100
365-075E	7	75	5,5	50
365-080E	8	80	8,4	50
365-090E	9	90	10,0	25
365-100E	10	100	14,0	25

Bevestigingshaken, houtschroefdraad
Decken Haken, holzgewinde
Ceiling hooks, woodscrew
Crochets à plafond, filet à bois
 Verzinkt/verzinkt/galvanized/zingué



	Materiaal Draht Wire Fil Ø mm	Totale lengte Ganze Länge Total length Longueur total mm	Gewicht Gewicht Weight Poids kg/100	St./Pcs.
Art.no.				
370-09E	8,8	145	9,1	20
370-10E	10,6	145	10,0	10

Bevestigingshaken, metrische draad
Decken Haken, metrisches Gewinde
Ceiling hooks, metric thread
Crochets à plafond, filet métrique
 Verzinkt/verzinkt/galvanized/zingué



	Draad Gewinde Thread Filtage	L1 mm	Materiaal Draht Wire Fil Ø mm	Totale lengte Ganze Länge Total length Longueur total mm	Gewicht Gewicht Weight Wieght Poids kg/100	St./Pcs.
Art.no.						
375-10E	M10	75	8,8	145	11,2	10
375-12E	M12	75	10,6	145	12,4	10

Schommelhaken met kunststof bus
Schaukelhaken mit Kunststoffbuchse
Swinging hooks with plastic bush
Crochets à bascule avec douille en plastique

Hout Schroefdraad/holzgewinde/woodscrew/filet à bois
 Verzinkt/verzinkt/galvanized/zingué



 Art.no.	Materiaal Draht Wire Fil ø mm	Totale lengte Ganze Länge Total length Longueur total mm	Gewicht Gewicht Weight Poids kg/100	St./Pcs.
376-180	10.6	180	22,0	

Schommelhaken met kunststof bus
Schaukelhaken mit Kunststoffbuchse
Swinging hooks with plastic bush
Crochets à bascule avec douille en plastique

Metrische draad/metrisches Gewinde/metric thread/filet métrique
 Verzinkt/verzinkt/galvanized/zingué



7

 Art.no.	Draad Gewinde Thread Filtage	Materiaal Draht Wire Fil ø mm	Totale lengte Ganze Länge Total length Longueur total mm	Gewicht Gewicht Weight Poids kg/100	St./Pcs.
377-180	M12	10.6	180	25,0	
377-250	M12	10.6	250	29,0	

09.2005

Triangels
Aufhängeösen
Triangles
Triangles

Blank/blank/polished/poli



	Art.no.	D ø mm	L mm	Gewicht Gewicht Weight Poids kg/100	St./Pcs.
	361-08B	8	40	8,00	100
Op aanvraag - Auf Anfrage - Upon request - À demande					

Gelaste ringen
Geschweißte Ringe
Welded rings
Anneaux soudés

Verzinkt/verzinkt/galvanized/zingué

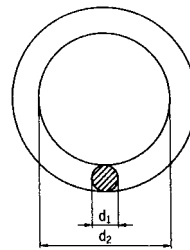



	Art.no.	Materiaal Draht Wire Fil d1 ø mm	Binnendiameter Innendurchmesser Inside diameter Diamètre intérieure d2 mm	Gewicht Gewicht Weight Poids kg/100	St./Pcs.
	360-043E	4	30	1,1	100
	360-054E	5	40	2,1	100
	360-064E	6	40	3,5	100
	360-065E	6	50	4,0	100
	360-073E	7	35	4,2	50
	360-075E	7	50	5,4	50
	360-083E	8	35	5,6	50
	360-085E	8	50	7,3	50
	360-086E	8	60	8,7	50
	360-088E	8	80	11,0	25
	360-095E	9	50	9,3	50
	360-096E	9	60	10,2	50
	360-104E	10	40	9,6	50
	360-105E	10	50	11,8	50
	360-126E	12	60	21,5	25
	360-130E	12	100	30,0	
Andere maten op aanvraag Andere Abmessungen auf Anfrage Other sizes upon request Autres dimensions à demande					

09.2005

Gelaste D' ringen
Geschweißte D' Ringe
Welded D' rings
Anneaux D'soudés

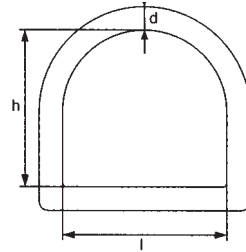
Verzinkt/verzinkt/galvanized/zingué



	Materiaal Draht Wire Fil d Ø mm	Breedte Breite Width Largeur l mm	Hoogte Höhe Height Hauteur h mm	Gewicht Gewicht Weight Poids kg/100	St./Pcs.
Art.no.					
362-052E	5	25	22	1,19	100
362-064E	6	40	30	3,20	100
362-075E	7	50	45	5,50	50
362-084E	8	40	45	7,50	50
362-105E	10	50	50	14,00	50

S-Haken
S-Haken
S-Hooks
Crochets esses

Verzinkt/verzinkt/galvanized/zingué

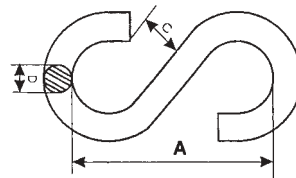

7

	D Ø mm	A mm	C mm	Gewicht Gewicht Weight Poids kg/100	St./Pcs.
Art.no.					
220-03E	3	23,8	4	0,3	100
220-04E	4	31,8	5,5	0,8	100
220-05E	5	39,7	8	1,5	100
220-06E	6	47,6	8,7	2,6	100
220-07E	7	62	11,2	4,2	50
220-08E	8	65,1	11,9	6,7	50
220-10E	10	80,1	13,5	12,4	25

09.2005

Katrollen, rollen van nylon
Blockseilrollen, Rollen aus Nylon
Tackles, pulleys made of nylon
Poulies, galets de nylon

Enkel/einfach/single/single

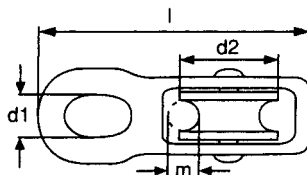



 Art.no.	m	d2	d1	l	Gewicht	St./Pcs.
	mm	mm	mm	mm	kg/100	
951-05E	5	15	10	50	2,5	25
951-06E	6	20	11	60	4,0	25
951-07E	7	25	12	70	6,0	25
951-08E	8	30	13	80	7,5	10
951-09E	9	40	14	93	12,5	10
951-12E	12	50	15	113	19,0	5

7

Katrollen, rollen van nylon
Blockseilrollen, Rollen aus Nylon
Tackles, pulleys made of nylon
Poulies, galets de nylon

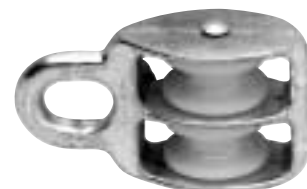
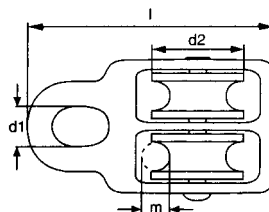
Dubbel/doppelt/double/double





 Art.no.	m	d2	d1	l	Gewicht	St./Pcs.
	mm	mm	mm	mm	kg/100	
952-05E	5	15	10	50	4,0	25
952-06E	6	20	11	60	6,0	25
952-07E	7	25	12	70	9,0	25
952-08E	8	30	13	80	14,0	10
952-09E	9	40	16	105	26,0	10
952-12E	12	50	16	117	42,0	5

09.2005

**Windhaken
Sturmhaken
Gate hooks
Crochets de contrevent**

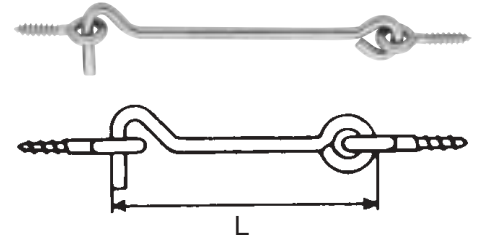
Verzinkt/verzinkt/galvanized/zingué



 Art.no	Materiaal Draht Wire Fil ø mm	L mm	Gewicht Gewicht Weight Poids kg/100 St./Pcs.
389-030E	2,6	30	0.40 100
389-040E	2,9	40	0.50 100
389-050E	3,3	50	0.90 100
389-060E	3,5	60	1.30 100
389-070E	3,7	70	1.50 100
389-080E	3,9	80	1.90 100
389-100E	4,4	100	2.60 50
389-120E	4,6	120	3.10 50
389-140E	5,0	140	4.10 50
389-160E	5,0	160	5.00 50
389-180E	5,2	180	5.90 50
389-200E	5,8	200	7.40 50
389-225E	5,8	225	7.90 50
389-250E	6,0	250	9.80 50
389-300E	6,0	300	12.30 50
389-400E	8,0	400	24.40 10
389-500E	8,0	500	29.20 10
389-600E	8,0	600	33.10 10

09.2005

Zonder aansprakelijkheid / Unverbindlich / Without warranty / Sans engagement

**Schroefogen
Eisengewindeösen
Screw eyes
Pitons à vis**

Verzinkt/verzinkt/galvanized/zingué

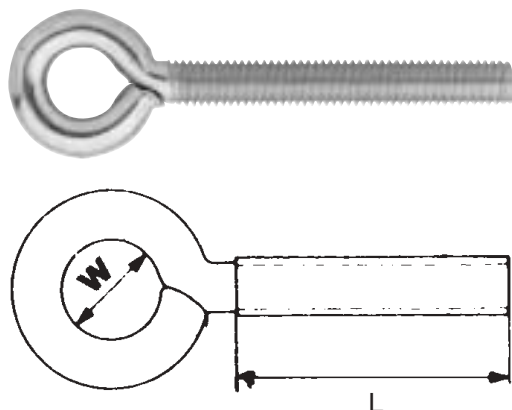

 Art.no.	Draad Gewinde Thread Filtage	L mm	W mm	Gewicht Gewicht Weight Poids kg/100	St./Pcs.
390-031E	M 3	10	5	0,16	100
390-032E	M 3	15	5	0,20	100
390-042E	M 4	15	6	0,36	100
390-043E	M 4	20	6	0,43	100
390-044E	M 4	40	6	0,51	100
390-052E	M 5	20	8	0,70	100
390-053E	M 5	30	8	0,82	100
390-054E	M 5	40	8	0,92	100
390-055E	M 5	50	8	1,06	100
390-056E	M 5	60	8	1,18	100
390-062E	M 6	20	10	1,15	100
390-064E	M 6	40	10	1,49	100
390-066E	M 6	60	10	1,83	100
390-068E	M 6	80	10	2,17	100
390-082E	M 8	20	12	2,18	50
390-084E	M 8	40	12	2,78	50
390-086E	M 8	60	12	3,37	50
390-088E	M 8	80	12	3,97	50
390-810E	M 8	100	12	4,56	50
390-104E	M 10	40	14	5,36	50
390-106E	M 10	60	14	6,32	50
390-108E	M 10	80	14	7,28	50

7

09.2005

**Schroefogen
Ringschrauben
Screw eyes
Pitons à vis**

Verzinkt/verzinkt/galvanized/zingué

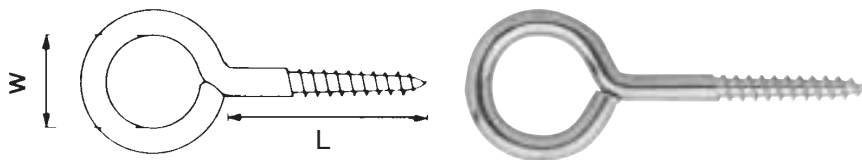

 Art.no.	Materiaal Draht Wire Fil			Gewicht Gewicht Weight Poids kg/100	St./Pcs
	Ø mm	L mm	W mm		
391-0603E	2	6	3	0.10	200
391-0804E	2,3	8	4	0.10	200
391-1004E	2,3	10	4	0.10	200
391-1006E	2,9	10	6	0.20	100
391-1204E	2,3	12	4	0.10	100
391-1206E	2,9	12	6	0.20	100
391-1208E	3,3	12	8	0.30	100
391-1606E	2,9	16	6	0.20	100
391-1608E	3,3	16	8	0.30	100
391-1610E	3,7	16	10	0.50	100
391-2008E	3,3	20	8	0.40	100
391-2010E	3,7	20	10	0.50	100
391-2012E	4,1	20	12	0.70	100
391-2510E	3,7	25	10	0.60	100
391-2512E	4,1	25	12	0.80	100
391-3010E	3,7	30	10	0.60	100
391-3012E	4,1	30	12	0.80	100
391-3014E	4,3	30	14	1.00	100
391-3016E	4,6	30	16	1.20	100
391-3018E	5,0	30	18	1.50	100
391-4014E	4,3	40	14	1.10	100
391-4016E	4,6	40	16	1.30	100
391-4018E	5,0	40	18	1.70	100
391-4020E	5,2	40	20	2.00	100
391-5018E	5,0	50	18	1.90	100
391-5020E	5,2	50	20	2.10	100

**Schroefduimen
Schraubhaken
Squarehooks
Gonds à vis**

Verzinkt/verzinkt/galvanized/zingué



 Art.no.	Draad Gewinde Thread Filtage		Gewicht Gewicht Weight Poids kg/100	St./Pcs.
		L mm		
392-440E	M 4	40	0.40	100
392-450E	M 4	50	0.40	100
392-540E	M 5	40	0.60	100
392-550E	M 5	50	0.70	100
392-560E	M 5	60	0.80	100
392-650E	M 6	50	1.00	100
392-660E	M 6	60	1.20	100
392-860E	M 8	60	2.20	100

09.2005

Zonder aansprakelijkheid / Unverbindlich / Without warranty / Sans engagement

**Schroefduimen
Schraubhaken
Squarehooks
Gonds à vis**

Verzinkt/verzinkt/galvanized/zingué

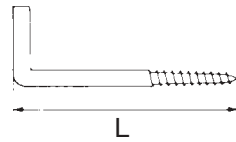



 Art.no.	Materiaal		L mm	Gewicht	
	Draht Wire Fil ø mm			Gewicht Gewicht Weight Poids kg/100	St./Pcs.
393-020E	2,3		20	0.10	200
393-025E	2,3		25	0.10	100
393-030E	2,6		30	0.20	100
393-040E	3,3		40	0.30	100
393-050E	3,9		50	0.60	100
393-060E	3,9		60	0.70	100
393-080E	4,6		80	1.30	100
393-100E	5,0		100	1.90	100

7

**Sleufschroefduimen
Schlitzhaken
Slot squarehooks
Fente gonds à vis**

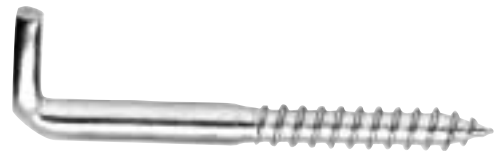
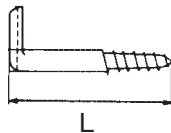
Verzinkt/verzinkt/galvanized/zingué



 Art.no.	Materiaal		L mm	Gewicht	
	Draht Wire Fil ø mm			Gewicht Gewicht Weight Poids kg/100	St./Pcs.
394-430E	4,4		30	0.40	100
394-440E	4,4		40	0.50	100
394-450E	4,4		50	0.60	100
394-530E	5,2		30	0.60	100
394-540E	5,2		40	0.70	100
394-550E	5,2		50	0.80	100
394-560E	5,2		60	1.00	100
394-665E	5,8		65	1.30	100
394-680E	5,8		80	1.60	100
394-6100E	5,8		100	1.90	100

Kruis schroefduimen
Kreuz Schraubhaken
Cross squarehooks
Croix gonds à vis

Verzinkt/verzinkt/galvanized/zingué

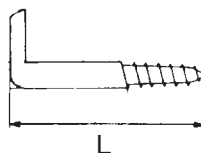

 Art.no.	Materiaal		Gewicht		St./Pcs.
	Draht Wire Fil ø mm	L mm	Gewicht Gewicht Weight Poids kg/100		
395-040E	5,2	40	0.80		100
395-050E	5,2	50	0.90		100
395-065E	5,8	65	1.40		100
395-080E	5,8	80	1.70		100
395-100E	5,8	100	2.10		100

Schroefhaken
Schraubhaken
Cup hooks
Crochets d'armoires

Verzinkt/verzinkt/galvanized/zingué

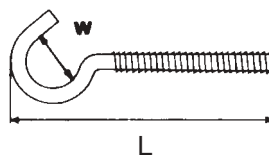

7

 Art.no.	Draad Gewinde Thread Filtage	Gewicht		St./Pcs.	
		L mm	W mm		Gewicht Gewicht Weight Poids kg/100
396-440E	M 4	40	10,5	0.50	100
396-450E	M 4	50	10,5	0.60	100
396-550E	M 5	50	11	0.90	100
396-560E	M 5	60	11	1.00	100
396-650E	M 6	50	14	1.40	100
396-660E	M 6	60	14	1.50	100

09.2005

**Schroefhaken
Schraubhaken
Cup hooks
Crochets d'armoires**

Verzinkt/verzinkt/galvanized/zingué

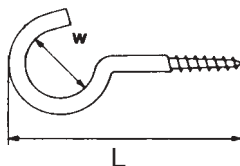

 Art.no.	Materiaal Draht Wire Fil			Gewicht Gewicht Weight Poids kg/100	St./Pcs.
	ø mm	L mm	W mm		
397-020E	2,3	20	6	0.10	200
397-025E	2,3	25	8	0.20	100
397-030E	2,6	30	11	0.20	100
397-040E	3,3	40	14	0.40	100
397-050E	3,5	50	17	0.60	100
397-060E	3,7	60	20	0.80	100
397-070E	4,0	70	23	1.10	100
397-080E	4,4	80	26	1.30	100
397-100E	5,0	100	30	2.20	100
397-120E	5,0	120	30	2.60	100

**Schroefhaken, zwaar
Schraubhaken, schwer
Cup hooks, heavy
Crochets d'armoires, forts**

Verzinkt/verzinkt/galvanized/zingué

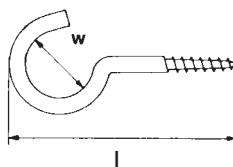

 Art.no.	Materiaal Draht Wire Fil			Gewicht Gewicht Weight Poids kg/100	St./Pcs.
	ø mm	L mm	W mm		
398-080E	5,0	80	23	1.80	50
398-100E	5,8	100	25	2.90	50
398-120E	6,0	120	27	3.80	50
398-140E	6,3	140	29	4.60	50
398-160E	6,8	160	31	6.00	50

**Schroefhaken, klein
Schraubhaken, eng
Cup hooks, small
Crochets d'armoires, petit**

Verzinkt/verzinkt/galvanized/zingué

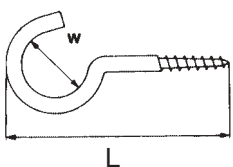

 Art.no.	Materiaal Draht Wire Fil			Gewicht Gewicht Weight Poids kg/100	St./Pcs.
	ø mm	L mm	W mm		
399-060E	3,5	60	11	0.70	100
399-080E	3,9	80	11	1.00	100
399-100E	4,4	100	11	1.50	100
399-120E	4,6	120	11	1.90	100

Borgveren, enkel
Federvorstecker, einfach
Spring-pins, single
Goupilles Béta, single

Geel verzinkt/gelb chromatiert/yellow galvanized/zingué jaune

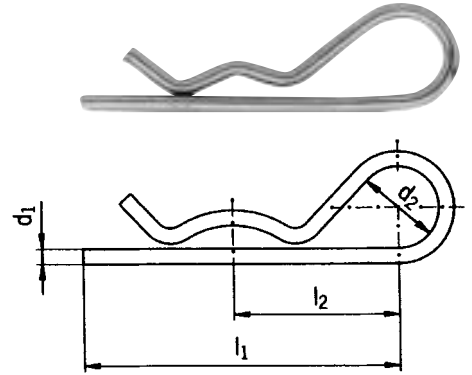

 Art.no.	d1	l1	d2	Voor as Für Welle For shaft Pour arbre ø mm	Gewicht Gewicht Weight Poids kg/100	St./Pcs.
	mm	mm	mm			
310-02E	2	44	12	9 - 14	0,3	50
310-03E	3	61	13	10 - 16	0,7	50
310-04E	4	77	18	16 - 20	1,4	50
310-05E	5	85	21	20 - 28	3,0	50
310-06E	6	82	31	28 - 40	4,4	50
310-07E	7	91	24	28 - 45	8,5	25
310-08E	8	130	36	30 - 45	13,4	25

Borgveren, dubbel
Federvorstecker, doppelt
Spring-pins, double
Goupilles Béta, double

Geel verzinkt/gelb chromatiert/yellow galvanized/zingué jaune

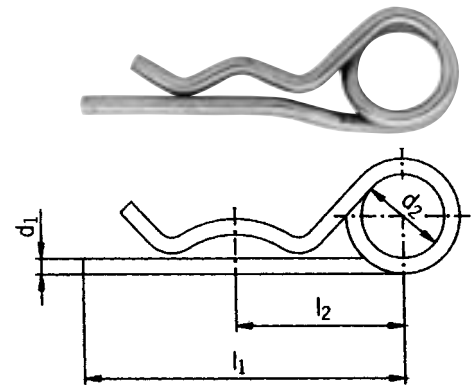



 Art.no.	d1	l1	d2	Voor as Für Welle For shaft Pour arbre ø mm	Gewicht Gewicht Weight Poids kg/100	St./Pcs.
	mm	mm	mm			
320-02E	2	53	9	8 - 14	0,4	50
320-03E	3	60	15	14 - 20	1,2	50
320-04E	4	75	23	17 - 24	3,0	50
320-05E	5	94	25	18 - 30	5,1	25
320-06E	6	122	28	24 - 36	9,4	25
320-07E	7	140	29	26 - 40	13,7	10

09.2005

**Borgpennen
Klappsplinte
Lynch-pins
Goupilles clips**

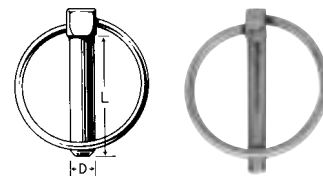
Geel verzinkt/gelb chromatiert/yellow galvanized/zingué jaune



	Art.no.	D mm	L mm	Gewicht Gewicht Weight Poids kg/100	St./Pcs.
	330-04E	4,5	35	1,2	50
	330-06E	6	40	1,6	50
	330-08E	8	44	3,7	50
	330-09E	9	40	3,7	50
	330-10E	10	45	4,2	50
	330-11E	11	44	4,8	50

**Buisborgpennen
Rohrklappsplinte
Pipepins
Goupilles clips pour tubes**

Geel verzinkt/gelb chromatiert/yellow galvanized/zingué jaune

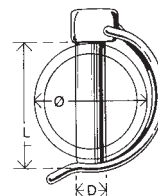

	Art.no.	D mm	L mm	Ø mm	Gewicht Gewicht Weight Poids kg/100	St./Pcs.
	331-840E	8	40	36	33,9	50
	331-845E	8	45	40	35,3	50
	331-850E	8	50	45	39,4	50
	331-860E	8	60	55	45,1	50
	331-1040E	10	40	36	48,5	50
	331-1050E	10	50	45	56,0	50
	331-1060E	10	60	55	62,8	50

**Assortiment borgveren/borgpennen
Sortiment Federvorstecker/Klappsplinte
Assortment spring-pins/lynch-pins
Assortiment goupilles clips/Béta**

	Art.no.	Borgveren Federvorstecker Spring-pins Goupilles Béta	Borgpennen Klappsplinte Lynch-pins Goupilles clips	Gewicht Gewicht Weight Poids kg/100	St./Pcs.
	300	5 St./Pcs. 3mm 5 St./Pcs. 4mm 5 St./Pcs. 5mm 3 St./Pcs. 6mm	3 St./Pcs. 8 mm 5 St./Pcs. 11 mm	89	

Zonder aansprakelijkheid / Unverbindlich / Without warranty / Sans engagement

**Wervels
Wirbel
Swivels
Tourets**

Verzinkt/verzinkt/galvanized/zingué



 Art.no.	Materiaal Draht Wire Fil Ø mm	Binnendiameter Innendurchmesser Inside diameter Dimension intérieure mm	Gewicht Gewicht Weight Poids kg/100	St./Pcs.
350-05E	5	20/26	3,2	100
350-06E	6	20/30	5,5	50
350-07E	7	25/37	9,0	50
350-08E	8	25/40	12,0	50
350-09E	9	25/45	17,7	25
350-10E	10	25/45	20,0	25

**Schapenwartels
Wirbel
Swivels
Tourets**

Vernikkeld/vernickelt/nickel-plated/nickelé



 Art.no.	Materiaal Draht Wire Fil Ø mm	Lengte Länge Length Longueur mm	Binnendiameter Innendurchmesser Inside diameter Dimension intérieure mm	Gewicht Gewicht Weight Poids kg/100	St./Pcs.
351-34N	3,4	42	9/16	1,1	100

7

**Koordkickers
Seilklampen
Rope-clamps
Taquets d'amarrage**

Vernikkeld/vernickelt/nickel-plated/nickelé





 Art.no.	Lengte Länge Length Longueur mm	Gewicht Gewicht Weight Poids kg/100	St./Pcs.
380-060N	60	1,00	100
380-110N	110	3,45	100
380-150N	150	5,75	50

09.2005

Vleeshaken
Fleischhaken
Meat hooks
Esses de boucher

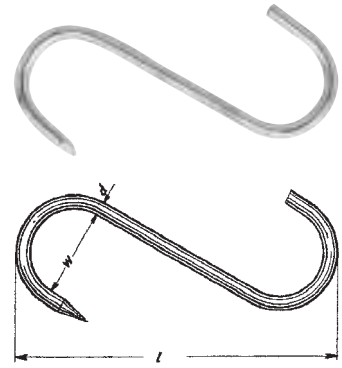
Vertind/verzinkt/tin plated/étamé



 Art.no.	d	l	w	Gewicht	St./Pcs.
	Ø mm	mm	mm	Gewicht Weight Poids kg/100	
225-080T	3,9	80	22	1,4	10
225-100T	4,6	100	27	2,5	10
225-120T	5,0	120	32	3,5	10
225-140T	5,4	140	40	4,7	10
225-160T	5,9	160	46	6,4	10
225-180T	6,5	180	52	8,8	10

7

Ketting wervels
Ketten Wirbels
Chain swivels
Tourets de chaîne

Vernikkeld/vernickelt/nickel plated/nickelé



 Art.no.	Ogen	Lengte	Gewicht	St./Pcs.
	Ösen Eye's Œil Ø mm	Länge Length Longueur mm	Gewicht Weight Poids kg/100	
166-45N	6 x 11	45	3,50	100
166-60N	10 x 16	60	5,50	100
166-70N	12 x 19	70	7,50	100
166-80N	11 x 22	80	10,80	100

**Aanlegring
Kripringe
Ringbolt
Anneau d'ecurie a ecrou**
Verzinkt/verzinkt/galvanized/zingué

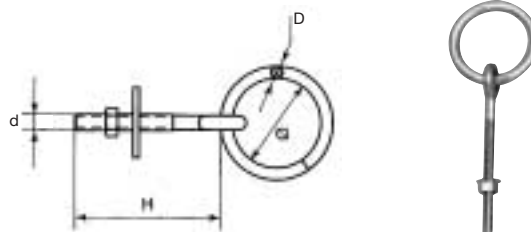

 Art.no.	d	H	D	Ø	Gewicht Gewicht Weight Poids kg/100	St./Pcs.
		mm	mm	mm		
595-880E	M 8	80	8	40	3,0	10
595-1080E	M10	80	10	45	5,0	10
595-10120E	M10	120	10	45	5,3	10
595-12120E	M12	120	12	50	8,4	10

**Aanlegring
Kripringe
Ringbolt
Anneau d'ecurie a ecrou**
Verzinkt/verzinkt/galvanized/zingué

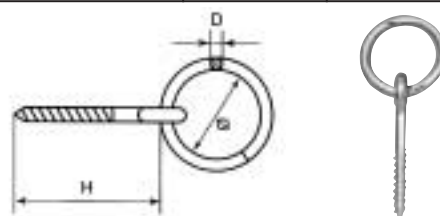

 Art.no.	d	H	D	Ø	Gewicht Gewicht Weight Poids kg/100	St./Pcs.
	mm	mm	mm			
596-630E	6	30	5	30	1,6	10
596-640E	6	40	6	35	2,2	10
596-850E	8	50	8	40	2,6	10
596-1070E	10	70	10	45	4,5	10
596-1280E	12	80	12	50	7,2	10

**U-beugels
U-bolzen
U-bolt
Etriers en U**
Verzinkt/verzinkt/galvanized/zingué

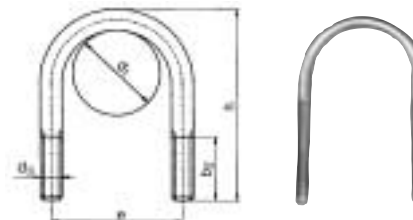

 Art.no.	d1	d3	b2	e	h	Gewicht Gewicht Weight Poids kg/100	St./Pcs.
	mm	mm	mm	mm	mm		
593-846E	15	M 8	20	30	46	3,0	100
593-854E	20	M 8	20	35	54	3,7	100
593-858E	25	M 8	25	43	58	4,0	100
593-868E	25	M 8	25	43	68	4,7	100
593-868BE	32	M 8	30	51	68	4,8	100
593-888E	40	M 8	30	58	88	6,2	100
593-1090E	40	M10	30	60	90	9,5	50
593-1090BE	50	M10	35	71	90	11,0	50

09.2005

