

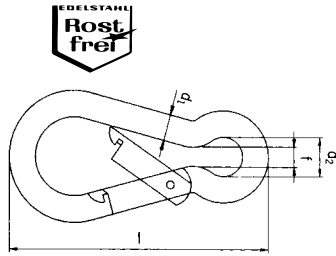

**Karabijnhaken  
Karabinerhaken  
Snap hooks  
Mousquetons**

Roestvaststaal, 316  
Rostfrei stahl, 316  
Stainless steel, 316  
Inox, 316



	Art.no.	l mm	d1 mm	d2 mm	f mm	Gewicht Gewicht Weight Poids kg/100	St./Pcs.
	245-05i	50	5	8	5,5	1,9	
	245-06i	60	6	8	6	2,7	
	245-07i	70	7	9,5	7	4,4	
	245-08i	80	8	12	8,5	6,5	
	245-10i	100	10	15	11	12,7	
	245-11i	120	11	20	13	18,0	

**Karabijnhaken met oog  
Karabinerhaken mit Öse  
Snap hooks with eye  
Mousquetons avec oeil**

Roestvaststaal, 316  
Rostfrei stahl, 316  
Stainless steel, 316  
Inox, 316

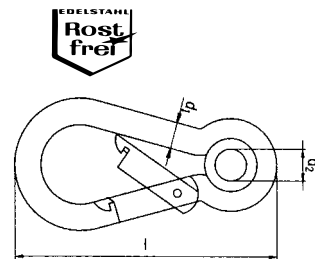

	Art.no.	l mm	d1 mm	d2 mm	Gewicht Gewicht Weight Poids kg/100	St./Pcs.
	2450-05i	50	5	6,5	1,9	
	2450-06i	60	6	7	3,0	
	2450-07i	70	7	8	4,6	
	2450-08i	80	8	10,5	7,2	
	2450-10i	100	10	13,5	13,8	
	2450-11i	120	11	13,5	20,0	

**Karabijnhaken met schroef  
Karabinerhaken mit Schraube  
Snap hooks with screw  
Mousquetons sécurités**

Roestvaststaal, 316  
Rostfrei stahl, 316  
Stainless steel, 316  
Inox, 316

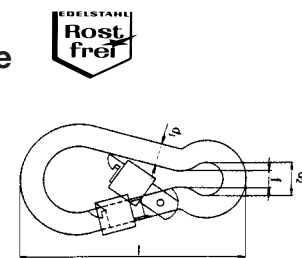

	Art.no.	l mm	d1 mm	d2 mm	f mm	Gewicht Gewicht Weight Poids kg/100	St./Pcs.
	245-08iS	80	8	12	9	6,5	
	245-10iS	100	10	15	11	12,7	
	245-11iS	120	11	16	12	18,0	

09.2005

**D-Sluitingen**  
**Schäkel gerade**  
**Shackles D'type**  
**Manilles droites**

Roestvaststaal, 316  
 Rostfrei stahl, 316  
 Stainless steel, 316  
 Inox, 316

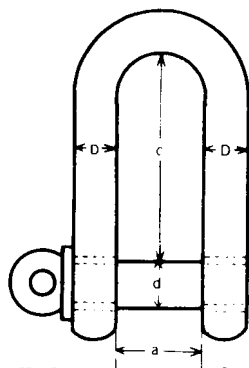

**Niet voor hijsdoeleinden/nicht für Hebezwecke/not for lifting purposes/ne pas pour desseins de levage**

 Art.no.	D/d mm	a mm	c mm	Gewicht	
				kg/100	St./Pcs.
910-04i*	4	8	14	2,7	
910-05i*	5	10	17,5	3,3	
910-06i*	6	12	21	4,0	
910-08i*	8	16	28	9,0	
910-10i*	10	20	35	14,0	
910-12i*	12	24	48	22,0	
910-16i*	16	32	56	50,0	
910-19i*	19	38	66,5	74,0	

\* Ook leverbaar in 304, Auch lieferbar in V2A, Also available in 304, Aussi livrable à 304

**Harp-sluitingen**  
**Schäkel geschweift**  
**Shackles bow-type**  
**Manilles lyres**

Roestvaststaal, 316  
 Rostfrei stahl, 316  
 Stainless steel, 316  
 Inox, 316

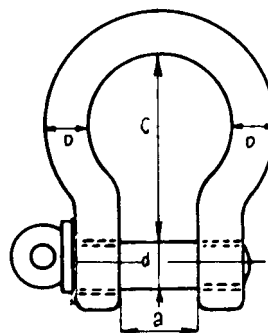

**Niet voor hijsdoeleinden/nicht für Hebezwecke/not for lifting purposes/ne pas pour desseins de levage**

 Art.no.	D/d mm	a mm	c mm	Gewicht	
				kg/100	St./Pcs.
911-04i*	4	8	14	2,7	
911-05i*	5	10	17,5	3,4	
911-06i*	6	12	21	4,3	
911-08i*	8	16	28	10,0	
911-10i*	10	20	35	15,0	
911-12i*	12	24	42	22,0	
911-16i*	16	32	56	54,0	
911-19i*	19	38	66,5	75,0	

\* Ook leverbaar in 304, Auch lieferbar in V2A, Also available in 304, Aussi livrable à 304

**Staaldraadklemmen**  
**Drahtseilklemmen**  
**Wire rope clips**  
**Serre-câbles**



Roestvaststaal, 316/Rostfrei stahl, 316/Stainless steel, 316/Inox, 316

	Voor kabel Für Seil For wire Pour câble Ø mm	Gewicht Gewicht Weight Poids kg/100	St./Pcs.
Art.no.			
920-02i	2	0,7	
920-03i*	3	1,2	
920-04i*	4	1,9	
920-05i*	5	2,4	
920-06i*	6	3,7	
920-08i*	8	5,5	
920-10i*	10	6,0	
920-12i*	12	8,0	
920-16i*	16	10,5	
920-19i	19	25,6	

\* Ook leverbaar in 304, Auch lieferbar in V2A, Also available in 304, Aussi livrable à 304

**Simplex staaldraadklemmen**  
**Simplex Drahtseilklemmen**  
**Simplex wire rope clips**  
**Serre-câbles simplex**



Roestvaststaal, 316/Rostfrei stahl, 316/Stainless steel, 316/Inox, 316

	Voor kabel Für Seil For wire Pour câble Ø mm	Bout (vast) Schraube (fest) Bolt (fixed) Boulon (ferme)	Gewicht Gewicht Weight Poids kg/100	St./Pcs.
Art.no.				
921-02i	2	M 3	0,35	
921-03i	3	M 4	0,60	
921-04i	4	M 5	1,15	
921-05i	5	M 5	1,60	
921-06i	6	M 6	2,40	

**Duplex staaldraadklemmen**  
**Duplex Drahtseilklemmen**  
**Duplex wire rope clips**  
**Serre-câbles duplex**



Roestvaststaal, 316/Rostfrei stahl, 316/Stainless steel, 316/Inox, 316

	Voor kabel Für Seil For wire Pour câble Ø mm	Bout (vast) Schraube (fest) Bolt (fixed) Boulon (ferme)	Gewicht Gewicht Weight Poids kg/100	St./Pcs.
Art.no.				
922-02i	2	M 3	0,7	
922-03i	3	M 4	1,1	
922-04i	4	M 5	2,2	
922-05i	5	M 5	2,9	
922-06i	6	M 6	4,7	

09.2005

Zonder aansprakelijkheid / Unverbindlich / Without warranty / Sans engagement

## Spanschroeven Spannschlösser Turnbuckles Tendeurs

Roestvaststaal, 316  
Rostfrei stahl, 316  
Stainless steel, 316  
Inox, 316

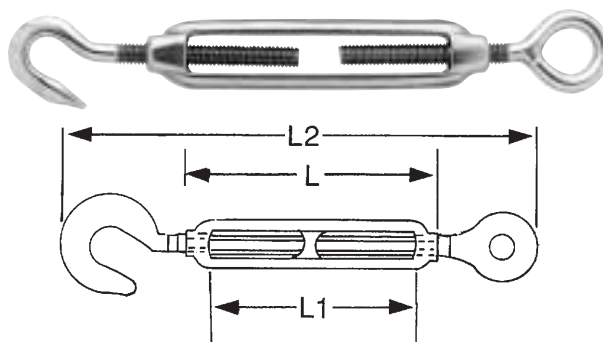

A= Haak/Oog      B= Oog/Oog      C= Haak/Haak  
A= Haken/Öse    B= Öse/Öse      C= Haken/Haken  
A= Hook/Eye      B= Eye/Eye      C= Hook/Hook  
A= Crochet/Oeil   B= Œil/Œil      C= Crochet/Crochet

Art.no.	Draad Draht Wire Fil Ø	L1 mm	L mm	L2 mm	Gewicht	
					Gewicht Weight Poids kg/100	St./Pcs.
930-05i	M 5	55	70	122	4,0	
930-06i	M 6	66	90	148	9,4	
930-08i	M 8	94	120	188	17,6	
930-10i	M 10	120	150	238	26,0	
930-12i	M 12	168	200	305	56,0	
930-16i	M 16	210	250	440	111,0	

## Wantspanners Wantenspanner Rigging screws Ridoirs

Roestvaststaal, 316  
Rostfrei stahl, 316  
Stainless steel, 316  
Inox, 316

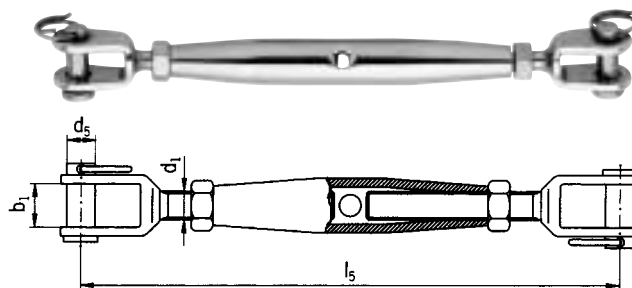



Art.no.	d1 mm	d5 mm	b1 mm	l5 max mm	l5 min mm	Gewicht	
						Gewicht Weight Poids kg/100	St./Pcs.
931-05iG	M 5	5	6,5	190	130	5,1	
931-06iG	M 6	6	7,5	220	150	9,0	
931-08iG	M 8	8	11	265	180	14,0	
931-10iG	M 10	9	12	300	220	24,0	
931-12iG	M 12	12	14	385	270	52,5	
931-16iG	M 16	16	17	500	360	100,0	
931-20iG	M 20	19	20	560	390	197,0	

09.2005

**Kousen  
Kauschen  
Thimbles  
Cosses**

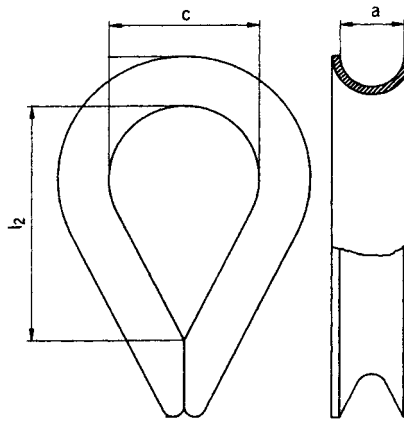
Roestvaststaal, 316  
Rostfrei stahl, 316  
Stainless steel, 316  
Inox, 316





 Art.no.	a	c	l2	Gewicht Gewicht Weight Poids kg/100	St./Pcs.
	mm	mm	mm		
940-02i	2	9	15	0,2	
940-03i*	3	10	16	0,4	
940-04i*	4	11	17	0,5	
940-05i*	5	13	20	0,6	
940-06i*	6	16	25	1,0	
940-08i*	8	20	32	1,8	
940-10i*	10	26	40	2,9	
940-12i*	12	28	45	4,6	
940-16i*	16	37	62	9,7	

\* Ook leverbaar in 304, Auch lieferbar in V2A, Also available in 304, Aussi livrable à 304

**Quick-links  
Quick-links  
Quick-links  
Maillons rapides**

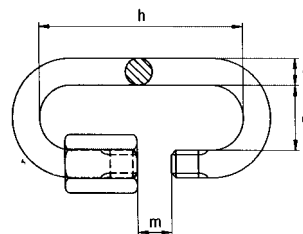
Roestvaststaal, 316  
Rostfrei stahl, 316  
Stainless steel, 316  
Inox, 316



 Art.no.	d	b	m	h	Gewicht Gewicht Weight Poids kg/100	St./Pcs.
	mm	mm	mm	mm		
945-03i	3,5	10,0	5,0	25,0	0,9	
945-04i	4	11,5	5,5	31,5	1,1	
945-05i	5	13,0	6,5	38,5	2,0	
945-06i	6	14,5	7,5	45,0	3,4	
945-07i	7	16,0	8,5	54,0	5,2	
945-08i	8	17,5	10,0	58,0	7,8	
945-10i	10	20,5	12,0	60,0	13,5	
945-12i	12	23,5	15,0	80,5	23,0	

09.2005

Zonder aansprakelijkheid / Unverbindlich / Without warranty / Sans engagement

**Sleutelringen  
Schlüsselringe  
Key rings  
Anneaux de clés**

Roestvaststaal, 304  
Rostfrei stahl, 304  
Stainless steel, 304  
Inox, 304





	Art.no.	Sleutelring Schlüsselring Key ring Anneau de cle Ø mm (uitwendig/außen/outside/extérieur)	Gewicht Gewicht Weight Poids kg/100	St./Pcs.
	1601-25i	25	0,20	
	1601-30i	30	0,37	

**Musketons  
Karabinerhaken  
Swivel snaps  
Mousquetons**

Roestvaststaal, 316  
Rostfrei stahl, 316  
Stainless steel, 316  
Inox, 316



	Art.no.	Lengte Länge Length Longueur mm	 mm - inch	Gewicht Gewicht Weight Poids kg/100	St./Pcs.
	50-10i	64	10,5 - 3/8"	1,8	
	50-12i	75	13,5 - 1/2"	2,7	
	50-16i	86	17 - 5/8"	3,1	
	50-20i	90	20,5 - 3/4"	3,2	
	50-32i	118	32 - 1 1/4"	8,0	

**S-Haken  
S-Haken  
S-Hooks  
Crochets esses**

Roestvaststaal, 316  
Rostfrei stahl, 316  
Stainless steel, 316  
Inox, 316

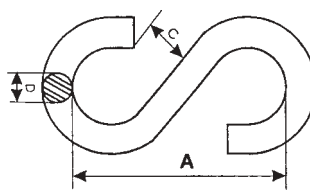

	Art.no.	D Ø mm	A mm	C mm	Gewicht Gewicht Weight Poids kg/100	St./Pcs.
	220-03i	3	30	7	0,4	
	220-04i	4	32,5	7,5	0,8	
	220-05i	5	37	10	1,5	
	220-06i	6	41,5	10,5	2,6	
	220-08i	8	48	11	6,7	

## TYPE 580



### Oogbouten Ringschrauben Eye-bolts Anneaux de levage, mâle

Roestvaststaal, 316  
Rostfrei stahl, 316  
Stainless steel, 316  
Inox, 316

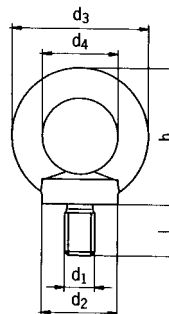

 Art.no.	d1	d3	d4	h	l	Gewicht Gewicht Weight Poids kg/100	St./Pcs.
	mm	mm	mm	mm	mm		
580-08i*	M 8	36	20	36	13	6	
580-10i*	M 10	45	25	45	17	11	
580-12i*	M 12	54	30	53	21	18	
580-16i*	M 16	63	35	62	27	28	
580-20i*	M 20	72	40	71	30	45	
580-24i*	M 24	90	50	90	36	74	
* Ook leverbaar in 304, Auch lieferbar in V2A, Also available in 304, Aussi livrable à 304							

## TYPE 582



### Oogmoeren Ringmuttern Eye-nuts Anneaux de levage, femelle

Roestvaststaal, 316  
Rostfrei stahl, 316  
Stainless steel, 316  
Inox, 316

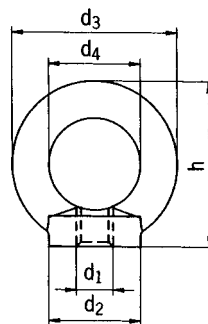

 Art.no.	d1	d3	d4	h	Gewicht Gewicht Weight Poids kg/100	St./Pcs.
	mm	mm	mm	mm		
582-08i*	M 8	36	20	36	5	
582-10i*	M 10	45	25	45	9	
582-12i*	M 12	54	30	53	16	
582-16i*	M 16	63	35	62	24	
582-20i*	M 20	72	40	71	36	
582-24i*	M 24	90	50	90	72	
* Ook leverbaar in 304, Auch lieferbar in V2A, Also available in 304, Aussi livrable à 304						

**Gelaste ringen  
Geschweißte Ringe  
Welded rings  
Anneaux soudés**

Roestvaststaal, 316  
Rostfrei stahl, 316  
Stainless steel, 316  
Inox, 316

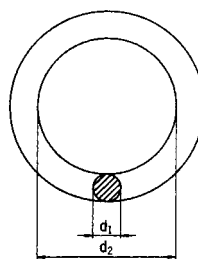

 Art.no.	Draad Draht Wire Fil d1 Ø mm	Binnendiameter Innendurchmesser Inside diameter Dimension intérieure d2 mm	Gewicht Gewicht Weight Poids kg/100	St./Pcs.
	360-043i 360-054i 360-064i	4 5 6	30 40 40	
360-065i 360-085i 360-086i	6 8 8	50 50 60	4,0 7,3 8,7	
360-096i 360-105i	9 10	60 50	10,2 11,8	

**Borgveren, enkel  
Federvorstecker, einfach  
Spring-pins, single  
Goupilles Béta, single**

Roestvaststaal  
Rostfrei stahl  
Stainless steel  
Inox

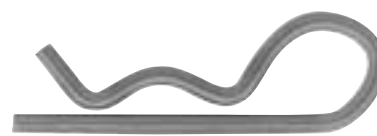
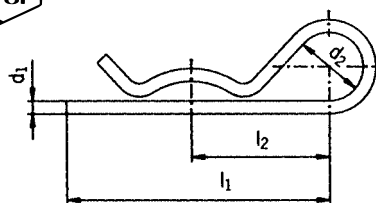

 Art.no.	d1 mm	l1 mm	d2 mm	Voor as Für Welle For shaft Pour arbre ø mm	Gewicht Gewicht Weight Poids kg/100	St./Pcs.
	310-02i 310-03i 310-04i	2 3 4	49 58 60	8 17 17	9 - 14 10 - 16 16 - 20	
310-05i 310-06i	5 6	82 104	25 31	20 - 28 28 - 40	3,23 4,74	



## TYPE 763



**Voetketting, langschalmig**  
**Ketten, langgliedrig**  
**Chain, long link**  
**Chaîne maillon longue**



Roestvaststaal, 316 / Rostfrei stahl, 316 / Stainless steel, 316 / Inox, 316

**Niet voor hijsdoeleinden/nicht für Hebezwecke/not for lifting purposes/ne pas pour desseins de levage**

	Draad Draht Wire Fil Ø mm	Inwendige lengte Innere Länge Inside length Longueur interieure mm	Uitwendige breedte Äußere Breite Outside width Largeur exterieure mm ≈	Gewicht Gewicht Weight Poids kg/100	Mtr.
Art.no					
763-03i	3	26	12	15	30
763-04i	4	32	16	27	30
763-05i	5	35	20	43	30
763-06i	6	42	24	63	30
763-08i	8	52	32	110	15

## TYPE 766



**Scheepsketting, kortschalmig**  
**Ketten, kurzgliedrig**  
**Chain, short link**  
**Chaîne maillon courte**



Roestvaststaal, 316 / Rostfrei stahl, 316 / Stainless steel, 316 / Inox, 316

**Niet voor hijsdoeleinden/nicht für Hebezwecke/not for lifting purposes/ne pas pour desseins de levage**

	Draad Draht Wire Fil Ø mm	Inwendige lengte Innere Länge Inside length Longueur interieure mm	Uitwendige breedte Äußere Breite Outside width Largeur exterieure mm ≈	Gewicht Gewicht Weight Poids kg/100	Mtr.
Art.no					
766-03i	3	16	12	16	30
766-04i	4	16	14	32	30
766-05i	5	18,5	17	50	30
766-06i	6	18,5	20	75	30
766-08i	8	24	26	135	15

**Genovese ketting**  
**Genovese Ketten**  
**Genovese chain**  
**Chaîne genovese**

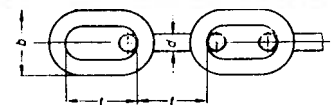

Roestvaststaal, 316 / Rostfrei stahl, 316 / Stainless steel, 316 / Inox, 316

**Niet voor hijsdoeleinden/nicht für Hebezwecke/not for lifting purposes/ne pas pour desseins de levage**

	Draad Draht Wire Fil d mm	Inwendige lengte Innere Länge Inside length Longueur interieure t mm	Uitwendige breedte Äußere Breite Outside width Largeur exterieure b ≈ mm	Gewicht Gewicht Weight Poids kg/100	Mtr.
Art.no					
760-020i	1,9	13	9	6	50

09.2005

Zonder aansprakelijkheid / Unverbindlich / Without warranty / Sans engagement

## DIN 5686



### Viktorketting Knotenketten Victor chain Chaîne, victor

Roestvaststaal, 316 / Rostfrei stahl, 316 / Stainless steel, 316 / Inox, 316

Niet voor hijsdoeleinden/nicht für Hebezwecke/not for lifting purposes/ne pas pour desseins de levage

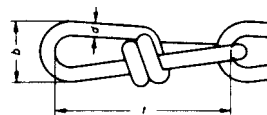

	Art.no.	d mm	t mm	b ≈ mm	Gewicht Gewicht Weight Poids kg/100	Mtr.
	5686-16i	1,6	23	7	5	30
	5686-20i	1,8	25	8	7	30
	5686-22i	2,0	28	9	8	30
	5686-25i	2,2	31	10	10	30
	5686-27i	2,5	35	11	14	30
	5686-30i	2,8	39	12,5	16	30

### Staalkabel Drahtseile Wire rope Câbles



Roestvaststaal, 316 / Rostfrei stahl, 316 / Stainless steel, 316 / Inox, 316

50 meter rol



	Art.no.	Afmeting Abmessung Dimension Dimension Ø mm	Constructie Konstruktion Construction Construction	Breukbelasting Bruchlast Breaking load Charge de rupture kN	Gewicht Gewicht Weight Poids kg/100	Mtr.
	119-01i R50	1	1 x 19	0,82	50	50
	719-02i R50	2	7 x 19	2,08	80	50
	719-03i R50	3	7 x 19	4,69	170	50
	719-04i R50	4	7 x 19	8,34	300	50
	719-05i R50	5	7 x 19	13,0	475	50
	719-06i R50	6	7 x 19	18,8	675	50
	719-08i R50	8	7 x 19	33,4	1170	50
	719-10i R50	10	7 x 19	52,1	1875	50

100 meter rol

	119-01i R100	1	1 x 19	0,82	100	100
	719-02i R100	2	7 x 19	2,08	160	100
	719-03i R100	3	7 x 19	4,69	340	100
	719-04i R100	4	7 x 19	8,34	600	100
	719-05i R100	5	7 x 19	13,0	950	100
	719-06i R100	6	7 x 19	18,8	1350	100
	719-08i R100	8	7 x 19	33,4	2340	100
	719-10i R100	10	7 x 19	52,1	3750	100

Zonder aansprakelijkheid / Unverbindlich / Without warranty / Sans engagement

**Wervels, oog-oog  
Wirbel, Öse-Öse  
Swivels, eye-eye  
Tourets œil-œil**

Roestvaststaal, 316  
Rostfrei stahl, 316  
Stainless steel, 316  
Inox, 316

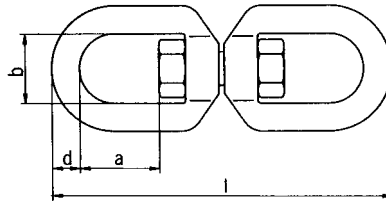

	Art.no.	d mm	b mm	l mm	Gewicht Gewicht Weight Poids kg/100	St./Pcs.
	355-05i	5	13	60	3,4	
	355-06i	6	15	65	5,9	
	355-08i	8	20	90	11,6	
	355-10i	10	24	115	13,5	
	355-13i	13	32	154	33,0	
	355-16i	16	39	188	50,0	
	355-19i	19	41	231	73,5	

**Wervels, oog-gaffel  
Wirbel, Öse-Gabel  
Swivels, eye-jaw  
Tourets, œil-chape**

Roestvaststaal, 316  
Rostfrei stahl, 316  
Stainless steel, 316  
Inox, 316

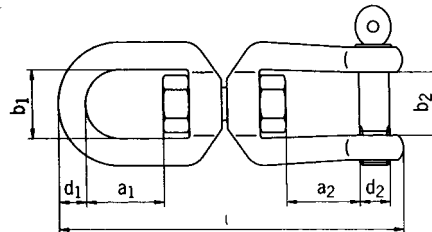



	Art.no.	d1 mm	b1 mm	l mm	Gewicht Gewicht Weight Poids kg/100	St./Pcs.
	356-06i	6	12	66	8,0	
	356-08i	8	16	94	14,8	
	356-10i	10	20	118	16,0	
	356-13i	13	26	152	37,5	
	356-16i	16	32	188	55,0	
	356-19i	19	38	229	79,0	

09.2005

**Wervels, gaffel-gaffel  
Wirbel, Gabel-Gabel  
Swivels, jaw-jaw  
Tourets, chape-chape**

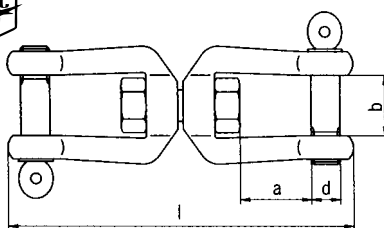
Roestvaststaal, 316  
Rostfrei stahl, 316  
Stainless steel, 316  
Inox, 316



				Gewicht Gewicht Weight Poids kg/100	St./Pcs.
Art.no.	d mm	b mm	l mm		
357-06i	6	12	66	9,0	
357-08i	8	16	94	16,8	
357-10i	10	20	118	18,0	
357-13i	13	26	152	39,5	
357-16i	16	32	188	57,0	
357-19i	19	38	229	83,5	

**Vleeshaken  
Fleischhaken  
Meat hooks  
Esses de boucher**

Roestvaststaal, 304  
Rostfrei stahl, 304  
Stainless steel, 304  
Inox, 304

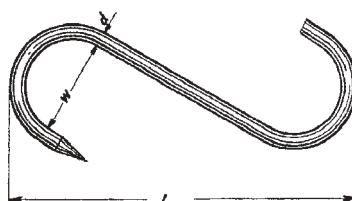



				Gewicht Gewicht Weight Poids kg/100	St./Pcs.
Art.no.	d mm	l mm	w mm		
225-080i	3,9	80	22	1,4	
225-100i	4,6	100	27	2,5	
225-120i	5,0	120	32	3,5	
225-140i	5,4	140	40	4,7	
225-160i	5,9	160	46	6,4	
225-180i	6,5	180	52	8,8	

9

**Terminal-Gaffelspanner**  
**Terminal-Gabelspanner**  
**Terminal-Jaw rigging screws**  
**Tendeurs embouts-chape**

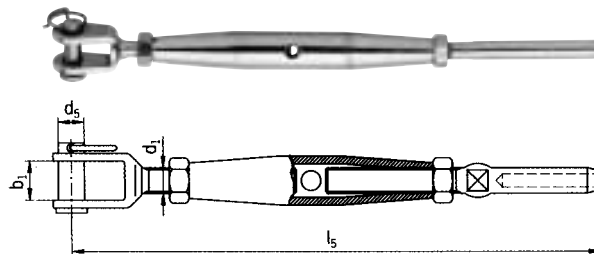
Roestvaststaal, 316  
 Rostfrei stahl, 316  
 Stainless steel, 316  
 Inox,316



 Art.no.	Draad Gewinde Thread Filtage d1	Kabel Draht Wire Câble Ø mm	l5 min mm	l5 max mm	b1 mm	d5 mm	Gewicht Gewicht Weight Poids kg/100	St./Pcs.
	932-05iTG	M 5	2,5	150	210	6,5	5	
932-06iTG	M 6	3	170	240	7,5	6	9.0	
932-08iTG	M 8	4	200	280	11	8	14.0	
932-10iTG	M 10	5	225	310	12	9	24.0	
932-12iTG	M 12	6	285	400	14	12	52.5	
932-16iTG	M 16	8	355	500	17	16	100.0	
932-20iTG	M 20	10	415	580	20	20	197.0	

**Draadterminals**  
**Gewindeterminals**  
**Studterminals**  
**Embouts à sertir**

Roestvaststaal, 316  
 Rostfrei stahl, 316  
 Stainless steel, 316  
 Inox,316

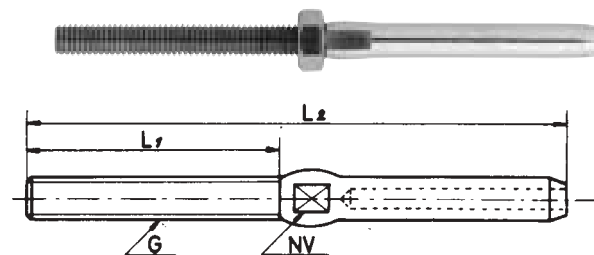

 Art.no.	Draad Gewinde Thread Filtage G	Kabel Draht Wire Câble Ø mm	L1 mm	L2 mm	NV mm	Gewicht Gewicht Weight Poids kg/100	St./Pcs.
	2100-05i	M 5	2,5	38	70	4	
2100-06i	M 6	3	40	80	5,5	1.8	
2100-08i	M 8	4	52	102	7	3.2	
2100-10i	M 10	5	63	130	8	5.2	
2100-12i	M 12	6	68	142	11	9.6	
2100-16i	M 16	8	89	175	14	27.2	
2100-20i	M 20	10	122	258	15	43.8	

09.2005

**Oogterminals  
Augterminals  
Eyeterminals  
Embouts à œil**

Roestvaststaal, 316  
Rostfrei stahl, 316  
Stainless steel, 316  
Inox,316

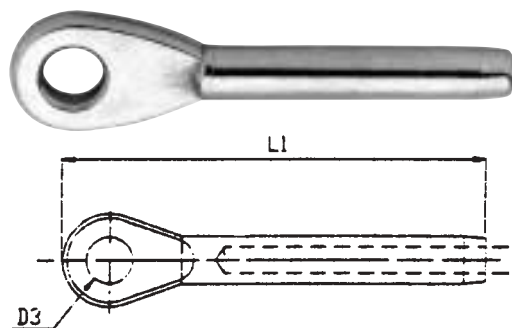

Art.no.	Kabel Draht Wire Câble Ø mm	L1 mm	D3 mm	A mm	Gewicht Gewicht Weight Poids kg/100		St./Pcs.
2400-025i	2,5	51	6	4		1.6	
2400-03i	3	64	6,5	4		1.6	
2400-04i	4	74	8	6		2.3	
2400-05i	5	91	10	7		3.9	
2400-06i	6	108	12,5	8		9.0	
2400-08i	8	140	14,5	10		20.2	
2400-10i	10	160	16,4	12		30.7	

**Gaffelterminals  
Gabelterminals  
Jawterminals  
Embouts à chape**

Roestvaststaal, 316  
Rostfrei stahl, 316  
Stainless steel, 316  
Inox,316

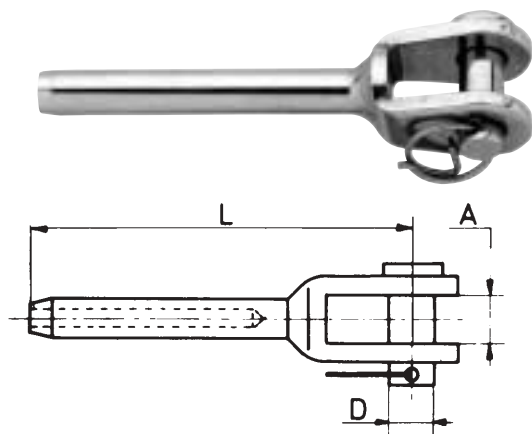

Art.no.	Kabel Draht Wire Câble Ø mm	D mm	A mm	L mm	Gewicht Gewicht Weight Poids kg/100		St./Pcs.
2500-025i	2,5	5	6	70		2.3	
2500-03i	3	5	7,5	80		2.8	
2500-04i	4	6	10	102		5.1	
2500-05i	5	8	12	130		7.7	
2500-06i	6	9	14	142		17.9	
2500-08i	8	14	15	175		34.6	
2500-10i	10	16	17	258		60.0	

**Aanleggring  
Krippringe  
Ringbolt  
Anneau d'ecurie a ecrou**

Roestvaststaal, 316  
Rostfrei stahl, 316  
Stainless steel, 316  
Inox, 316

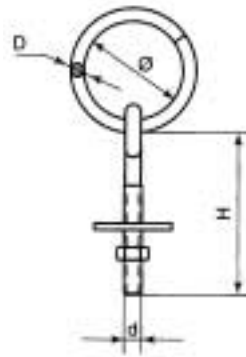

 Art.no.	d mm	H mm	D mm	Ø mm	Gewicht Gewicht Weight Poids kg/100	St./Pcs.
	595-675i	M 6	75	6	35	2,2
595-875i	M 8	75	8	45	3,0	
595-10100i	M10	100	9	50	5,1	
595-12120i	M12	120	12	60	8,4	

**Aanleggring  
Krippringe  
Ringbolt  
Anneau d'ecurie a ecrou**

Roestvaststaal, 316  
Rostfrei stahl, 316  
Stainless steel, 316  
Inox, 316

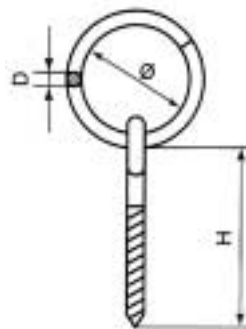



 Art.no.	d mm	H mm	D mm	Ø mm	Gewicht Gewicht Weight Poids kg/100	St./Pcs.
	596-675i	6	75	6	35	2,3
596-875i	8	75	8	45	2,7	
596-10100i	10	100	9	50	4,7	
596-12120i	12	120	12	60	7,9	

09.2005

**Oogbout  
Ringschrauben  
Eye-bolts  
Anneau de levage**

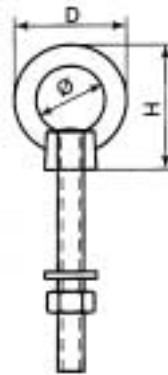
Roestvaststaal, 316  
Rostfrei stahl, 316  
Stainless steel, 316  
Inox, 316



 Art.no.					Gewicht Gewicht Weight Poids kg/100	St./Pcs.	
	L mm	D mm	Ø mm	b mm			
598-640i	M 6	40	26	16	30	2,9	
598-660i	M 6	60	26	16	30	3,3	
598-680i	M 6	80	26	16	30	3,7	
598-880i	M 8	80	31	19	34	6,3	
598-8100i	M 8	100	31	19	34	6,7	
598-10100i	M10	100	39	25	42	10,3	
598-12120i	M12	120	45	29	47	16,5	

**U-beugels  
U-bolzen  
U-bolt  
Etriers en U**

Roestvaststaal, 316  
Rostfrei stahl, 316  
Stainless steel, 316  
Inox, 316

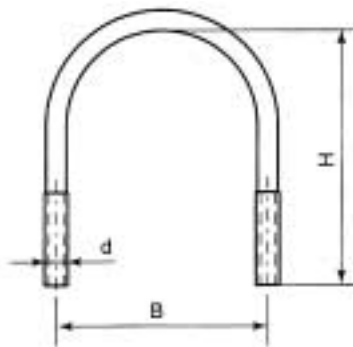

 Art.no.				Gewicht Gewicht Weight Poids kg/100	St./Pcs.
	B mm	d mm	H mm		
593-635i	28	M6	36	2,4	
593-645i	31	M6	45	2,5	
593-655i	38	M6	53	2,6	
593-875i	46	M8	74	7,7	
593-880i	60	M8	82	7,9	
593-885i	72	M8	87	8,1	

09.2005



**U-beugels, met plaat**  
**U-bolzen, mit Platte**  
**U-bolt, with plate**  
**Etriers en U, avec ron**

Roestvaststaal, 316  
 Rostfrei stahl, 316  
 Stainless steel, 316  
 Inox, 316

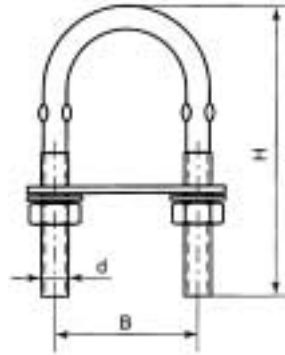



 Art.no.	B	d	H	Gewicht	St./Pcs.
	mm	mm	mm	kg/100	
590-460i	30	M 4	60	1,8	
590-560i	30	M 5	60	2,4	
590-660i	30	M 6	60	3,6	
590-670i	30	M 6	70	3,7	
590-690i	30	M 6	90	3,9	
590-864i	30	M 8	64	7,6	
590-880i	35	M 8	80	8,1	
590-8100i	35	M 8	100	8,7	
590-1090i	50	M10	90	10,5	
590-10130i	50	M10	130	13,0	
590-12150i	60	M12	150	23,0	

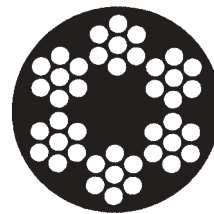

**Staalkabel, PVC bekleed, wit**  
**Drahtseile, PVC ummantelt, weiß**  
**Wire rope, PVC coated, white**  
**Câbles, gaine PVC, blanc**

Roestvaststaal, 316  
 Rostfrei stahl, 316  
 Stainless steel, 316  
 Inox, 316



 Art.no.	Afmeting	Constructie	Breuklast	Gewicht	Mtr.
	Abmessung	Konstruktion	Bruchlast	kg/100	
	Dimension	Construction	Breaking load	Poids	
	Dimension	Construction	Charge de rupture	kg/100	
	Ø mm		kN		
7x7-46iPR10	4/6	7 x 7	10,2	850	100
7x7-46iPR50	4/6	7 x 7	10,2	525	50

09.2005

## TYPE 766



### Scheepsketting op rol Ketten auf Rollen Chain on reel Chaîne sùr bobine

Roestvaststaal, 316

Rostfrei stahl, 316

Stainless steel, 316

Inox, 316

**Niet voor hijsdoeleinden/nicht für Hebezwecke/not for lifting purposes/ne pas pour desseins de levage**



 Art.no	Draad Draht Wire Fil Ø mm	Lengte per rol Rolleninhalte Length per reel Longueur par bobine mtr.	Type rol Rollengröße Type of reel Type de bobine	Gewicht Gewicht Weight Poids kg/100	St./Pcs.
766-03iR	3	62	1	1180	
766-04iR	4	46	1	1620	
766-05iR	5	40	1	2150	
766-06iR	6	36	1	2850	
766-08iR	8	18	1	2552	

## TYPE 763

### Voetketting op rol Ketten auf Rollen Chain on reel Chaîne sùr bobine

Roestvaststaal, 316

Rostfrei stahl, 316

Stainless steel, 316

Inox, 316

**Niet voor hijsdoeleinden/nicht für Hebezwecke/not for lifting purposes/ne pas pour desseins de levage**



 Art.no	Materiaal Draht Wire Fil Ø mm	Lengte per rol Rolleninhalte Length per reel Longueur par bobine mtr.	Type rol Rollengröße Type of reel Type de bobine	Gewicht Gewicht Weight Poids kg/100	St./Pcs.
763-03iR	3	60	1	1080	
763-04iR	4	58	1	1390	
763-05iR	5	32	1	1870	
763-06iR	6	28	1	2420	
763-08iR	8	20	1	2570	

09.2005

**Windhaken  
Sturmhaken  
Gate hooks  
Crochets de contrevent**



Roestvaststaal, 304  
Rostfrei stahl, 304  
Stainless steel, 304  
Inox, 304

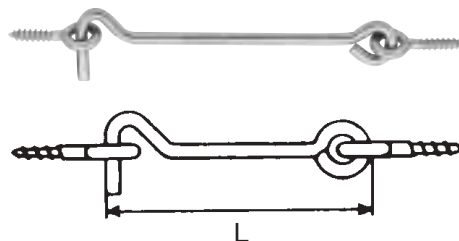



 Art.no	Materiaal		L mm	Gewicht Gewicht Weight Poids kg/100	St./Pcs.
	Draht Wire Fil ø mm				
389-080i	3,9		80	1,90	50
389-100i	4,4		100	2,60	50
389-120i	4,6		120	3,10	50
389-250i	6,0		250	9,80	50
389-300i	6,0		300	12,30	50

**Schroefogen  
Eisengewindeösen  
Screw eyes  
Pitons à vis**

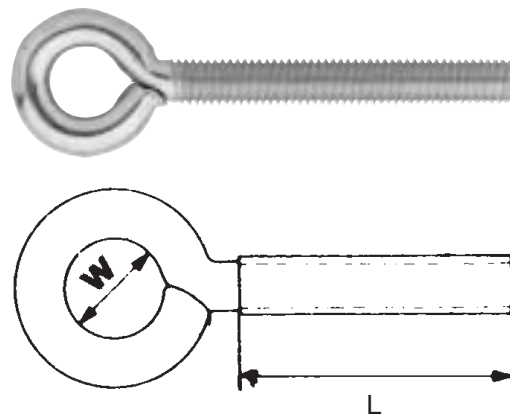

Roestvaststaal, 304  
Rostfrei stahl, 304  
Stainless steel, 304  
Inox, 304



 Art.no.	Draad Gewinde Thread Filtage	L mm	W mm	Gewicht Gewicht Weight Poids kg/100	St./Pcs.
390-042i	M 4	15	6	0,36	50
390-043i	M 4	20	6	0,43	50
390-052i	M 5	20	8	0,70	50
390-053i	M 5	30	8	0,82	50
390-054i	M 5	40	8	0,92	50
390-062i	M 6	20	10	1,15	50
390-064i	M 6	40	10	1,49	50
390-066i	M 6	60	10	1,83	50
390-082i	M 8	20	12	2,18	50
390-084i	M 8	40	12	2,78	50
390-086i	M 8	60	12	3,37	50
390-104i	M 10	40	14	5,36	50
390-106i	M 10	60	14	6,32	50

09.2005

Zonder aansprakelijkheid / Unverbindlich / Without warranty / Sans engagement

## Schroefogen Ringschrauben Screw eyes Pitons à vis

Roestvaststaal, 304  
Rostfrei stahl, 304  
Stainless steel, 304  
Inox, 304

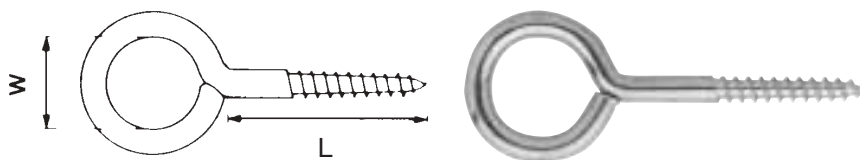

Art.no.	Materiaal	L mm	W mm	Gewicht Gewicht Weight Poids kg/100	St./Pcs
	Draht Wire Fil Ø mm				
391-1608i	3,3	16	8	0,30	50
391-2010i	3,7	20	10	0,50	50
391-2512i	4,1	25	12	0,80	50
391-3014i	4,3	30	14	1,00	50

## Schroefhaken Schraubhaken Cup hooks Crochets d'armoires

Roestvaststaal, 304  
Rostfrei stahl, 304  
Stainless steel, 304  
Inox, 304

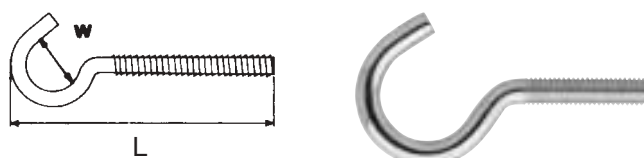

Art.no.	Draad	L mm	W mm	Gewicht Gewicht Weight Poids kg/100	St./Pcs.
	Gewinde Thread Filtage				
396-440i	M 4	40	10,5	0,50	50
396-550i	M 5	50	11	0,90	50
396-660i	M 6	60	14	1,50	50

## Schroefhaken Schraubhaken Cup hooks Crochets d'armoires

Roestvaststaal, 304  
Rostfrei stahl, 304  
Stainless steel, 304  
Inox, 304



Art.no.	Materiaal	L mm	W mm	Gewicht Gewicht Weight Poids kg/100	St./Pcs.
	Draht Wire Fil Ø mm				
397-040i	3,3	40	14	0,40	50
397-050i	3,5	50	17	0,60	50
397-060i	3,7	60	20	0,80	50

**Schroefhaken, klein  
Schraubhaken, eng  
Cup hooks, small  
Crochets d'armoires, petit**

Roestvaststaal, 304  
Rostfrei stahl, 304  
Stainless steel, 304  
Inox, 304

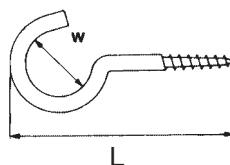

 Art.no.	Materiaal			Gewicht Gewicht Weight Poids kg/100	St./Pcs
	Draht Wire Fil Ø mm	L mm	W mm		
399-080i	3,9	80	11	1,00	50
399-100i	4,4	100	11	1,50	50

**Noodschakels  
Notglieder  
Lap-links  
Fausses mailles**

Roestvaststaal, 304  
Rostfrei stahl, 304  
Stainless steel, 304  
Inox, 304

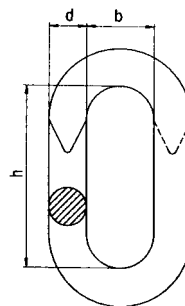

 Art.no.				Gewicht Gewicht Weight Poids kg/100	St./Pcs.
	d mm	b mm	h mm		
250-04i	4	8,0	19,0	0,80	50
250-06i	6	10,5	27,0	2,10	50

09.2005

