

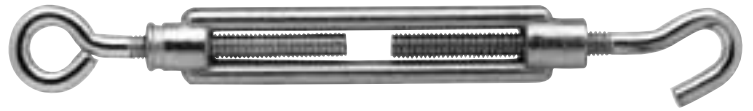

**Spanschroeven, handelsuitvoering**  
**Spannschlösser, handelsüblich**  
**Turnbuckles, commercial type**  
**Tendeurs, commercial**

Zamak, verzinkt  
 Zamak, verzinkt  
 Zinc die cast, galvanized  
 Zamak, zingué



A= Haak-Oog                      B= Oog-Oog                      C= Haak-Haak  
 A= Haken-Öse                    B= Öse-Öse                      C= Haken-Haken  
 A= Hook-Eye                      B= Eye-Eye                      C= Hook-Hook  
 A= Crochet-Œil                    B= Œil-Œil                        C= Crochet-Crochet

 Art.no.	Huislengte Schloßlänge Body length Longueur lanterne mm	Draad Gewinde Thread Filtage	Spanbereik Nachstellbarkeit Length Amovibilité mm	Gewicht Gewicht Weight Poids kg/100	St./Pcs.
800-05K	50	M 5	30	3,4	50
800-06K	60	M 6	35	5,0	50
800-08K	70	M 8	45	8,6	25
800-10K	80	M 10	50	16,4	25
800-05	70	M 5	50	3,8	50
800-06	100	M 6	70	6,8	50
800-08	110	M 8	80	12,2	25
800-10	120	M 10	85	21,0	20
800-12	130	M 12	90	38,4	10

02.2005

Zonder aansprakelijkheid / Unverbindlich / Without warranty / Sans engagement

## DIN 1480

### Spanschroefmoeren Spannschlossmuttern Turnbuckle-bodies Tendeurs

Verzinkt/verzinkt/galvanized/zingué

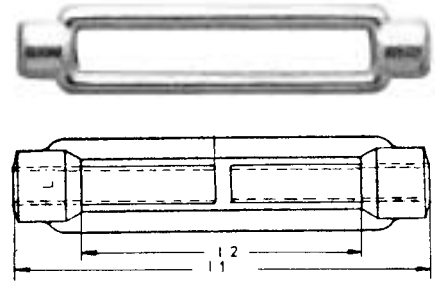

 Art.no.	Draad Gewinde Thread Filtage	Huislengte Schloßlänge Body length Longueur laterne L1 mm	Spanbereik Nachstellbarkeit Adjustable Amovibilité L2 mm	Gewicht Gewicht Weight Poids kg/100	St./Pcs.
1480-06M	M 6	110	80	5,5	
1480-08M	M 8	110	75	9,5	
1480-10M	M 10	125	85	15,5	
1480-12M	M 12	125	80	20,5	
1480-14M	M 14	140	90	31,0	
1480-16M	M 16	170	110	42,0	
1480-20M	M 20	200	130	74,0	
1480-22M	M 22	220	140	95,0	
1480-24M	M 24	255	170	130,0	
1480-30M	M 30	255	160	180,0	
1480-36M	M 36	295	180	310,0	

Op aanvraag  
Auf Anfrage  
Upon request  
À demande

## DIN 1480

### Spanschroeven met bladeinden Spannschlösser mit Blattschrauben Turnbuckles with plane-ends Tendeurs avec lameles

Verzinkt/verzinkt/galvanized/zingué

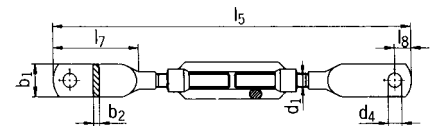

 Art.no.									Gewicht Gewicht Weight Poids kg/100	St./Pcs.
	d1	l1	adj.	b1	b2	d4	l8	l5		
1480-12PE	M12	125	80	30	5	13	16	345	48,4	
1480-16PE	M16	170	110	40	6	17	20,5	500	118,2	
1480-20PE	M20	200	130	50	6	17	27	505	188,8	

## DIN 1480

### Spanschroeven Spannschlösser Turnbuckles Tendeurs

Verzinkt/verzinkt/galvanized/zingué

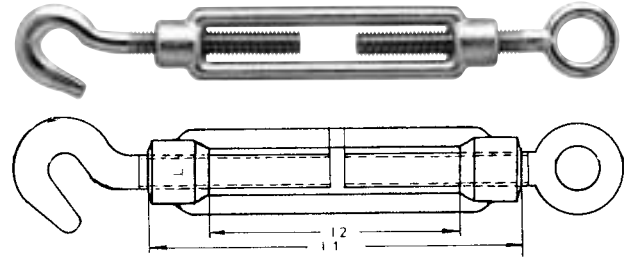

A= Haak-Oog	B= Oog-Oog	C= Haak-Haak
A= Haken-Öse	B= Öse-Öse	C= Haken-Haken
A= Hook-Eye	B= Eye-Eye	C= Hook-Hook
A= Crochet-Œil	B= Œil-Œil	C= Crochet-Crochet

 Art.no.	Draad Gewinde Thread Filtage	Huislengte Schloßlänge Body length Longueur laterne L 1 mm	Spanbereik Nachstellbarkeit Adjustable Amovibilité L 2 mm	Gewicht Gewicht Weight Poids kg/100	St./Pcs.
1480-05A	M 5	70	50	8	
1480-06	M 6	110	80	9	
1480-08	M 8	110	75	15	
1480-10	M 10	125	85	27	
1480-12	M 12	125	80	41	
1480-14	M 14	140	90	60	
1480-16	M 16	170	110	100	
1480-20	M 20	200	130	154	
1480-22	M 22	220	140	200	
1480-24	M 24	255	170	270	
1480-30	M 30	255	160	435	
1480-36	M 36	295	180	725	
Andere afmetingen op aanvraag Andere Abmessungen auf Anfrage Other sizes upon request Autres dimensions à demande					

02.2005

Zonder aansprakelijkheid / Unverbindlich / Without warranty / Sans engagement

## DIN 1480

### Spanschroeven met aanlaseinden Spannschlösser mit Anschweiß-Enden Turnbuckles with stubs Tendeurs avec tiges

Blank/blank/polished/brute

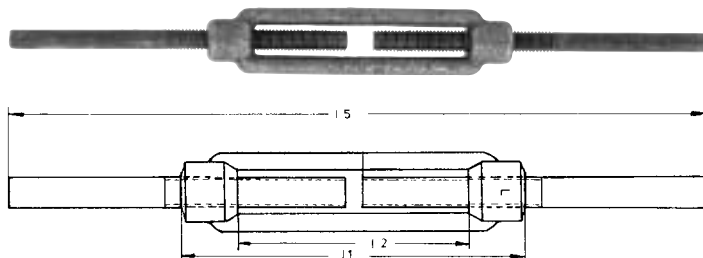

 Art.no.	Draad Gewinde Thread Filtage	Huislengte Schloßlänge Body length Longueur lanterne L 1 mm	Spanbereik Nachstellbarkeit Adjustable Amovibilité L 2 mm	Lengte Länge Length Longueur L 5 mm	Gewicht Gewicht Weight Poids kg/100	St./Pcs.
	1480-06AE	M 6	110	80	240	
1480-08AE	M 8	110	75	240	14	
1480-10AE	M 10	125	85	300	29	
1480-12AE	M 12	125	80	300	40	
1480-14AE	M 14	140	90	330	66	
1480-16AE	M 16	170	110	400	89	
1480-20AE	M 20	200	130	440	160	
1480-22AE	M 22	220	140	440	227	
1480-24AE	M 24	255	170	520	282	
1480-30AE	M 30	255	160	520	423	
1480-36AE	M 36	295	180	600	707	



### Aanlaseinden blank/Anschweiß-Enden blank/Stubs polished/Tiges brutes Moeren verzinkt/ Muttern verzinkt/ Bodies galvanized/Lanternes zingués

 Art.no.	Draad Gewinde Thread Filtage	Huislengte Schloßlänge Body length Longueur lanterne L 1 mm	Spanbereik Nachstellbarkeit Adjustable Amovibilité L 2 mm	Lengte Länge Length Longueur L 5 mm	Gewicht Gewicht Weight Poids kg/100	St./Pcs.
	1480-06E	M 6	110	80	240	
1480-08E	M 8	110	75	240	14	
1480-10E	M 10	125	85	300	29	
1480-12E	M 12	125	80	300	40	
1480-14E	M 14	140	90	330	66	
1480-16E	M 16	170	110	400	89	
1480-20E	M 20	200	130	440	160	
1480-22E	M 22	220	140	440	227	
1480-24E	M 24	255	170	520	282	
1480-30E	M 30	255	160	520	423	
1480-36E	M 36	295	180	600	707	

# DIN 1478

## Spanschroefmoeren Spannschlossmuttern Turnbuckle-bodies Tendeurs

Verzinkt/verzinkt/galvanized/zingué

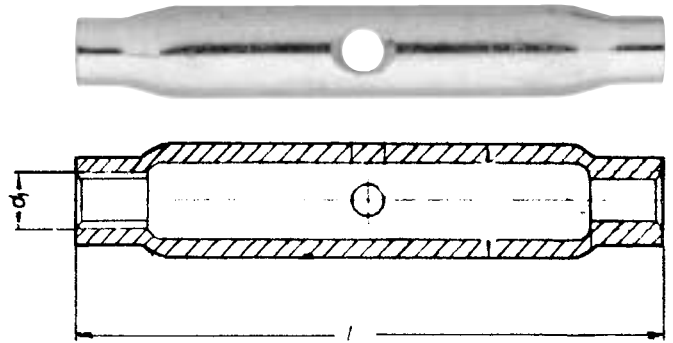

 Art.no.	Draad Gewinde Thread Filtage D1	Huislengte Schloßlänge Body length Longueur lanterne L mm	Gewicht Gewicht Weight Poids kg/100	St./Pcs.
1478-06M	M 6	110	10,2	
1478-08M	M 8	110	12,2	
1478-10M	M 10	125	19,5	
1478-12M	M 12	125	24,1	
1478-16M	M 16	170	37,0	
1478-20M	M 20	200	68,0	
1478-24M	M 24	255	110,0	
1478-30M	M 30	255	147,0	
1478-36M	M 36	295	245,0	

Op aanvraag  
Auf Anfrage  
Upon request  
À demande

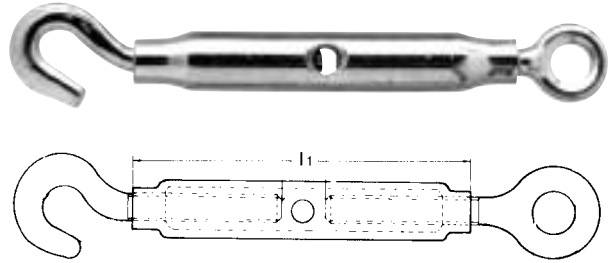

## DIN 1478

### Spanschroeven Spannschlösser Turnbuckles Tendeurs

Verzinkt/verzinkt/galvanized/zingué

A= Haak-Oog	B= Oog-Oog	C= Haak-Haak
A= Haken-Öse	B= Öse-Öse	C= Haken-Haken
A= Hook-Eye	B= Eye-Eye	C= Hook-Hook
A= Crochet-Œil	B= Œil-Œil	C= Crochet-Crochet

 Art.no.	Draad Gewinde Thread Filrtage	Huislengte Schloßlänge Body length Longueur lanterne L 1 mm	Spanbereik Nachstellbarkeit Adjustable Amovibilité mm	Gewicht Gewicht Weight Poids kg/100	St./Pcs.
1478-06	M 6	110	90	11	
1478-08	M 8	110	85	18	
1478-10	M 10	125	95	30	
1478-12	M 12	125	90	39	
1478-16	M 16	170	120	90	
1478-20	M 20	200	140	145	
1478-24	M 24	255	180	265	
1478-30	M 30	255	180	408	
1478-36	M 36	295	180	659	
Andere afmetingen op aanvraag Andere Abmessungen auf Anfrage Other sizes upon request Autres dimensions à demande					

02.2005

## DIN 1478

### Spanschroeven met aanlaseinden Spannschlösser mit Anschweiß-Enden Turnbuckles with stubs Tendeurs avec tiges

Blank/blank/polished/brute

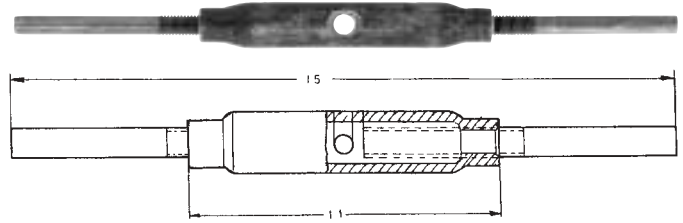

 Art.no.	Draad Gewinde Thread Filtage	Huislengte Schloßlänge Body length Longueur lanterne L 1	Spanbereik Nachstellbarkeit Adjustable Amovibilité	L 5 mm	Gewicht Gewicht Weight Poids kg/100	St./Pcs.
	mm	mm	mm			
1478-06AE	M 6	110	90	240	14	
1478-08AE	M 8	110	85	240	18	
1478-10AE	M 10	125	95	300	32	
1478-12AE	M 12	125	90	300	45	
1478-16AE	M 16	170	120	400	90	
1478-20AE	M 20	200	140	440	150	
1478-24AE	M 24	255	180	520	275	
1478-30AE	M 30	255	180	520	394	
1478-36AE	M 36	295	180	600	650	

5

## DIN 1478

### Spanschroeven met 2 gaffels Spannschlösser mit 2 Gabeln Turnbuckles with 2 jaws Ridoirs

Verzinkt/verzinkt/galvanized/zingué

Niet voor hijsdoeleinden/nicht für Hebezwecke/not for lifting purposes/ne pas pour desseins de levage

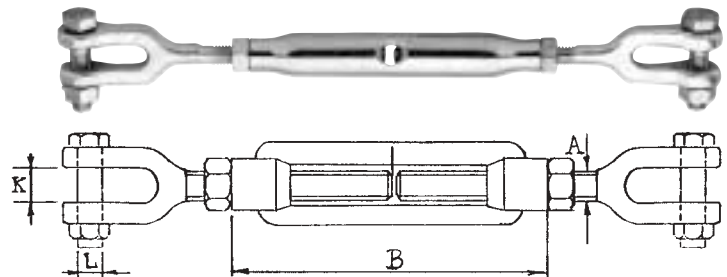

 Art.no.	Draad Gewinde Thread Filtage	Huislengte Schloßlänge Body length Longueur lanterne			Gewicht Gewicht Weight Poids kg/100	St./Pcs.
	A	K mm	L	B mm		
1478-08G	M 8	9	M 6	110	26	
1478-10G	M 10	11	M 8	125	45	
1478-12G	M 12	13	M 10	125	66	
1478-16G	M 16	18	M 12	170	151	
1478-20G	M 20	20,5	M 16	200	293	
1478-24G	M 24	26	M 20	255	500	
1478-30G	M 30	33	M 24	255	997	

Op aanvraag : Spanschroef Din 1480 met 2 gaffels  
Auf Anfrage : Spannschlösser Din 1480 met 2 Gabeln  
Upon request : Turnbuckles Din 1480 with 2 jaws  
A demande : Ridoirs Din 1480

02.2005

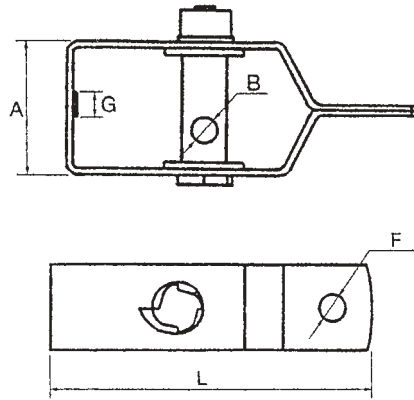

**Draadspanners  
Drahtspanner  
Wire tenseser  
Raidisseurs**



Art.no.

no.	Lengte Länge Length Longueur L mm	A mm	B mm	F mm	G mm
-----	---	---------	---------	---------	---------

Gewicht Gewicht Weight Poids kg/100
---

St./Pcs.

Vuurverzinkt/feuerverzinkt/hot dipped galvanized/galvanisé

407-02V	2	100	30	4,5	7	7	8,3
407-03V	3	120	32	5	7	7	12,5
407-04V	4	130	42	5	11	16	22,0

Groen/grün/green/vert

407-01P	1	90	29	4,5	7	7	7,5
407-02P	2	100	30	4,5	7	7	8,3
407-03P	3	120	32	5	7	7	12,5
407-04P	4	130	42	5	11	16	22,0